

ISOMETRIC VIEW
FOR REFERENCE ONLY

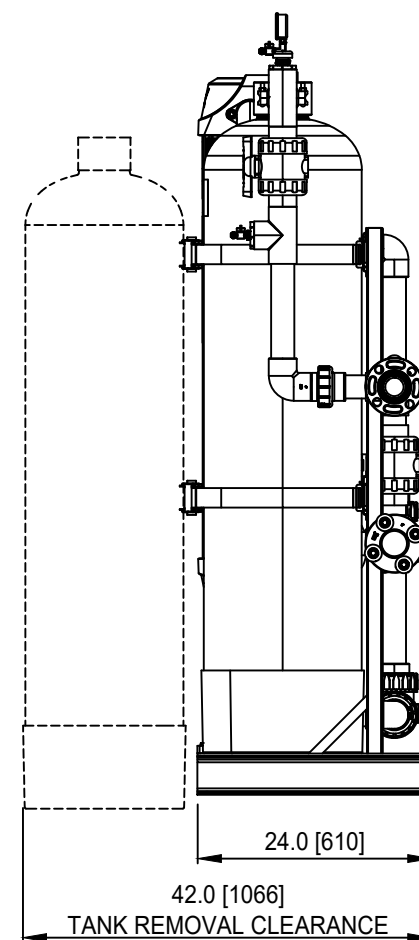

NOTES:
 1. ALL DIMENSIONS SHOWN ARE IN INCHES [MILLIMETERS].
 1. ALL CALLOUTS ENCLOSED IN PARENTHESES () OR UNDERLINED ARE FOR REFERENCE ONLY.

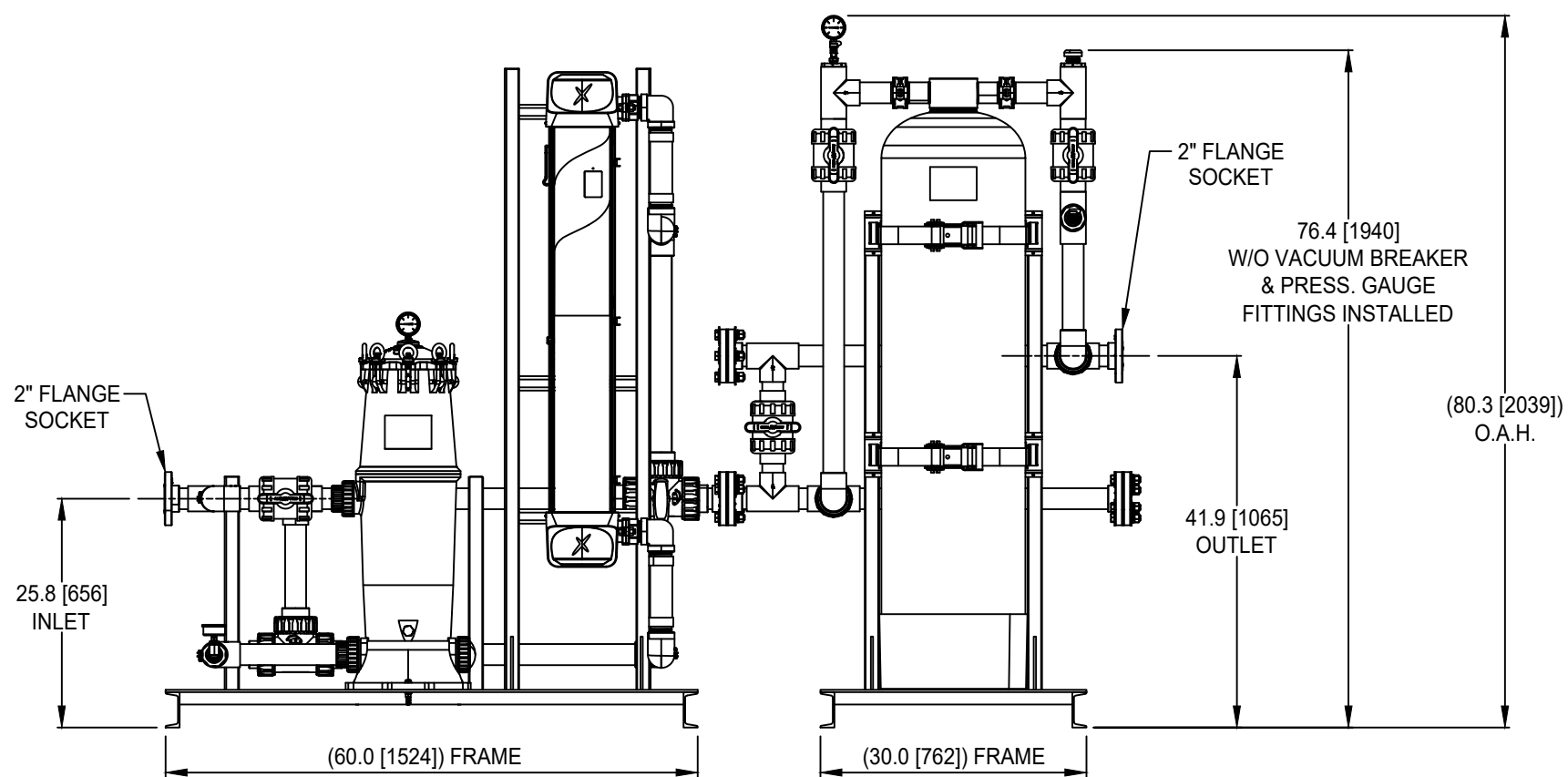

Fort Worth, TX
 www.lyncbywatts.com

TITLE
WQAS-070 DIMENSIONAL DRAWING

DWN.BY K.S. DATE 042324
 SCALE NTS
 REV.BY _____ DATE _____

DWG. NO.:
AP-L-1097

REV
B