













Pipe Temp.	Line Type
CW	
HW	
Recirc	
Tempered	

	T&P RELIEF VALVE
	PUMP
	MIXING VALVE
	BALL VALVE
	CHECK VALVE
	STRAINER
	BACKFLOW PREVENTER

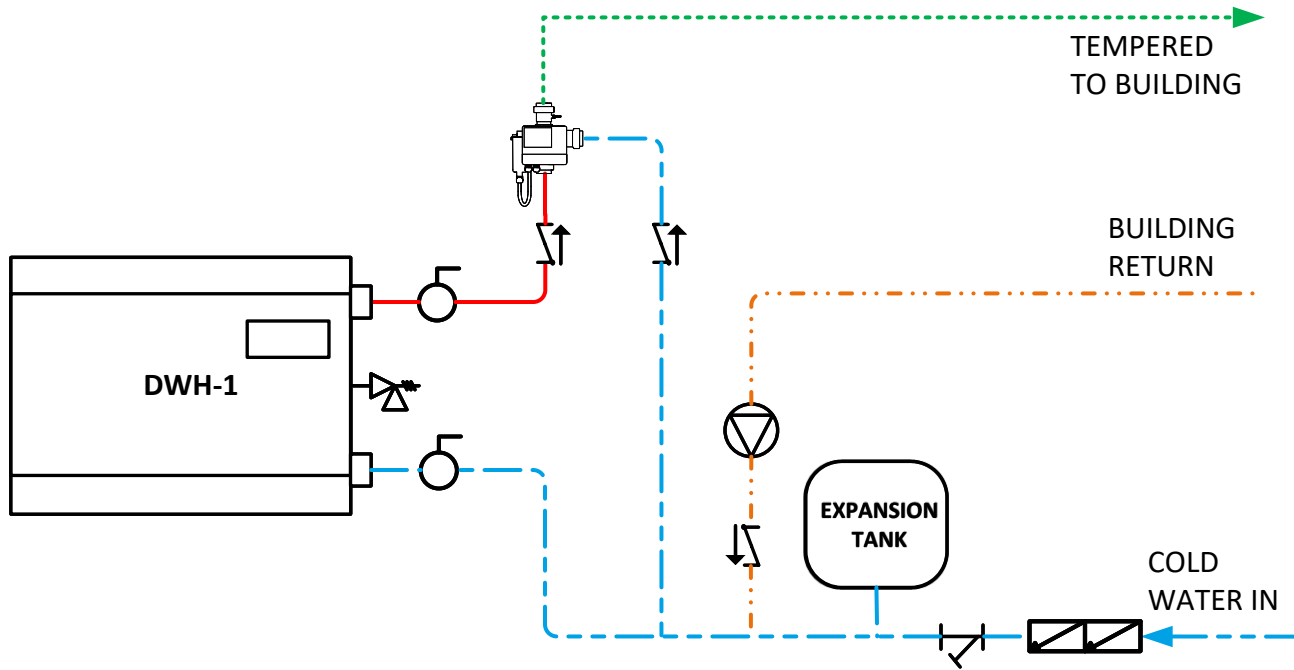

NOTES:

- 1) FOR ACTUAL SIZES AND LOCATIONS OF PIPING AND OTHER CONNECTIONS TO THE HEATER, SEE DIMENSIONAL DRAWING.
- 2) LOCAL CODES AND AUTHORITIES SHOULD BE CONSULTED.
- 3) PIPE T&P VALVE TO WITHIN 6" OF DRAIN WITH NO SHUTOFF VALVES OR RESTRICTION IN THE LINE; OR PER LOCAL CODE REQUIREMENTS.
- 4) RECIRC PUMP DETERMINED BY PLUMBING ENGINEER AND MINIMUM FLOW VARIES BY MIXING VALVE SIZE.
- 5) REFER TO VALVE MANUFACTURER PIPING INSTRUCTIONS.
- 6) ENSURE ALL PIPE DIAMETERS ARE SIZED ADEQUATELY TO HANDLE THE FLOW VOLUME (GPM) AT A MAXIMUM WATER VELOCITY OF 6 FEET PER SECOND.
- 7) THE FOLLOWING COMPONENTS SHALL BE FIELD SOURCED: CHECK VALVES, STRAINERS, BALL VALVES, BALANCING VALVES, PUMPS, TEMPERATURE SENSORS, EXPANSION TANKS.

		Fort Worth, TX 76134 Blauvelt, NY 10913	
BOLT MINI – SINGLE UNIT POINT OF USE INSTALLATION			
DRWN. BY <u>BJJ</u>	DATE <u>12/3/25</u>	DWG. NO: <u>SD-L-1373</u>	REV. <u>A</u>